

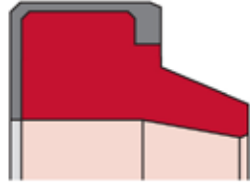

CNC Machined Wiper Seal: DA103

Submit completed form by email to info@nuraseal.com or by fax to 905.795-8381



Seal Profile: DA103

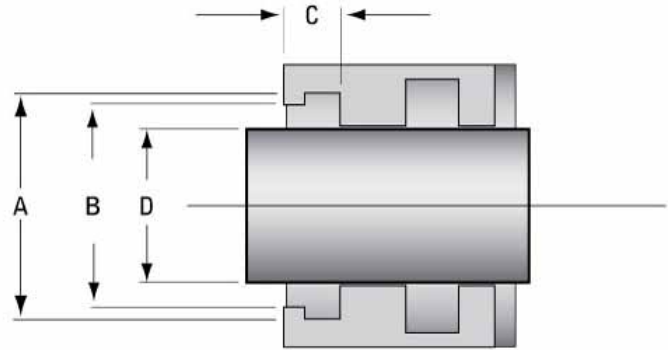

Dimensions

A: _____

B: _____

C: _____

D: _____

Date Required: _____

Addition Comments: _____

Units: inch

mm

Material: _____

Quantity: _____

Contact Information

Name: _____

Company: _____

Address: _____

email: _____ phone: _____