



CNC Machined Wiper Seal: DA114

Submit completed form by email to info@nuraseal.com or by fax to 905.795-8381



Seal Profile: DA114

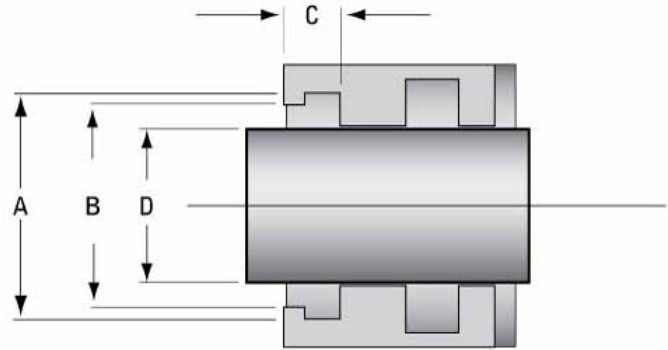

Dimensions

A: _____

Units: inch

B: _____

mm

C: _____

D: _____

Material: _____

Date Required: _____

Quantity: _____

Addition Comments: _____

Contact Information

Name: _____

Company: _____

Address: _____

email: _____ phone: _____